

4

3

2

1

B

B

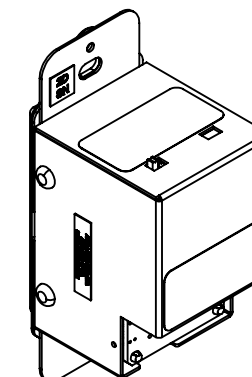
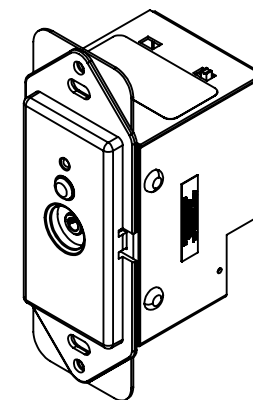
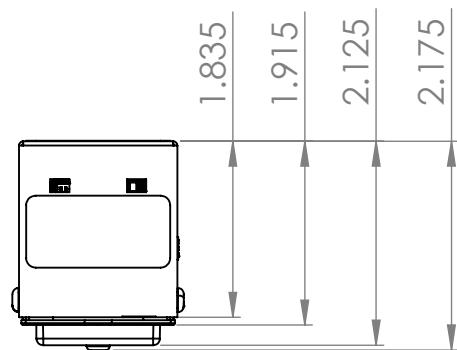

A

A

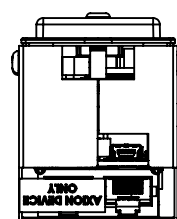
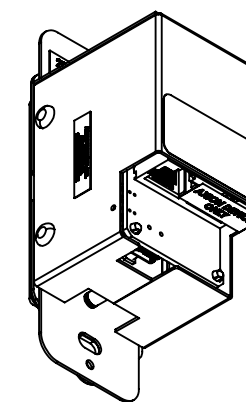
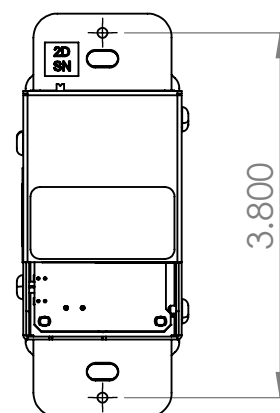
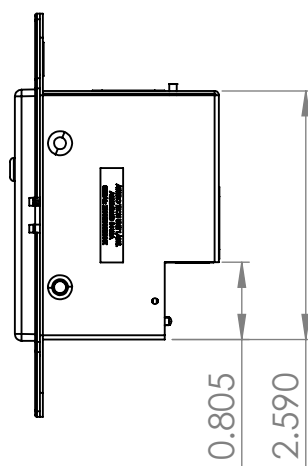
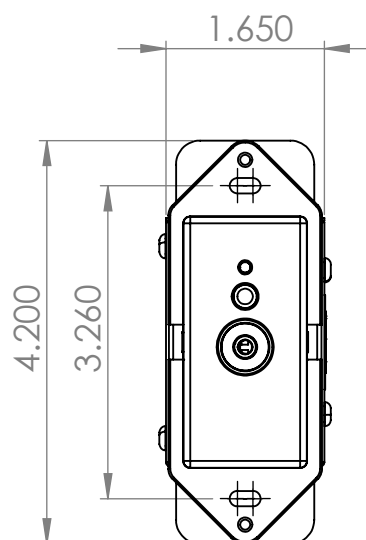
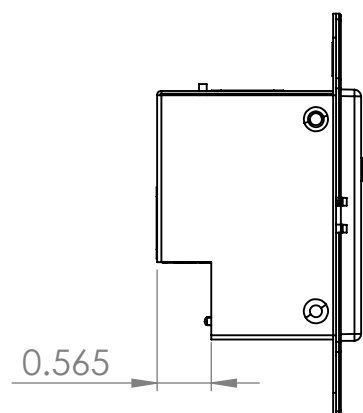

MATERIAL:		CLIENT NAME: <b>(C) 2018 ATTEROTECH</b>		
FINISH:		PART NO. <b>711-00013-01</b>		
UNLESS OTHERWISE SPECIFIED: DIMENSIONS ARE IN INCHES TOLERANCE: ANGLE +/- 1 DEG X.XX= +/- 0.01" X.XXX= +/- 0.010" DO NOT SCALE DRAWING	DESIGNER <b>MCH</b>	DATE <b>6/4/2020</b>	DESCRIPTION <b>INST DWG, ATTERO TECH, AXIOM BT1, US</b>	
	CUSTOMER	DATE		
THE INFORMATION CONTAINED IN THIS DOCUMENT IS ISSUED IN STRICT CONFIDENCE AND SHALL NOT BE REPRODUCED, COPIED OR USED FOR ANY PURPOSE WHATSOEVER AND MUST BE RETURNED UPON REQUEST.	MFG	DATE	SIZE <b>B</b>	CUST NO.
	APPROVED	DATE	DWG. NO. <b>711-00013-01</b>	DOC REV. <b>1.1</b>
			SCALE	SHEET TITLE
			SHEET <b>1 OF 1</b>	

4

3

2

1