

CXD-Q Amplifiers



User Manual

CXD4.2Q – 4 Channel, 2000 W Network Amplifier

CXD4.3Q – 4 Channel, 4000 W Network Amplifier

CXD4.5Q – 4 Channel, 8000 W Network Amplifier

TD-000438-01-A



EXPLANATION OF SYMBOLS

The term "**WARNING!**" indicates instructions regarding personal safety. If the instructions are not followed the result may be bodily injury or death.

The term "**CAUTION!**" indicates instructions regarding possible damage to physical equipment. If these instructions are not followed, it may result in damage to the equipment that may not be covered under the warranty.

The term "**IMPORTANT!**" indicates instructions or information that are vital to the successful completion of the procedure.

The term "**NOTE**" is used to indicate additional useful information.



The intent of the lightning flash with arrowhead symbol in a triangle is to alert the user to the presence of un-insulated "dangerous" voltage within the product's enclosure that may be of sufficient magnitude to constitute a risk of electric shock to humans.



The intent of the exclamation point within an equilateral triangle is to alert the user to the presence of important safety, and operating and maintenance instructions in this manual.



IMPORTANT SAFETY INSTRUCTIONS



WARNING!: TO PREVENT FIRE OR ELECTRIC SHOCK, DO NOT EXPOSE THIS EQUIPMENT TO RAIN OR MOISTURE.

1. Read these instructions.
2. Keep these instructions.
3. Heed all warnings.
4. Follow all instructions.
5. Do not use this apparatus near water.
6. Clean only with a dry cloth.
7. Do not block any ventilation opening. Install in accordance with the manufacturer's instructions.
8. Do not install near any heat sources such as radiators, heat registers, stoves, or other apparatus that produce heat.
9. To reduce the risk of electrical shock, the power cord shall be connected to a mains socket outlet with a protective earthing connection.
10. Do not defeat the safety purpose of the polarized or grounding-type plug. A polarized plug has two blades with one wider than the other. A grounding type plug has two blades and a third grounding prong. The wide blade or the third prong are provided for your safety. If the provided plug does not fit into your outlet, consult an electrician for replacement of the obsolete outlet.
11. Protect the power cord from being walked on or pinched particularly at plugs, convenience receptacles, and the point where they exit from the apparatus.
12. Only use attachments/accessories specified by the manufacturer.
13. Unplug this apparatus during lightning storms or when unused for long periods of time.
14. Refer all servicing to qualified service personnel. Servicing is required when the apparatus has been damaged in any way, such as power-supply cord or plug is damaged, liquid has been spilled or objects have fallen into the apparatus, the apparatus has been exposed to rain or moisture, does not operate normally, or has been dropped.
15. The appliance coupler, or the AC Mains plug, is the AC mains disconnect device and shall remain readily operable after installation. On units equipped with powerCon® connectors, the AC Mains disconnect device is the AC Mains plug only; do not use the appliance coupler.
16. Adhere to all applicable, local codes.
17. Consult a licensed, professional engineer when any doubt or questions arise regarding a physical equipment installation.
18. Do not use any aerosol spray, cleaner, disinfectant or fumigant on, near or into the apparatus. Clean only with a dry cloth.
19. Do not unplug the unit by pulling on the cord, use the plug.
20. Do not submerge the apparatus in water or liquids.
21. Keep ventilation opening free of dust or other matter.

Maintenance and Repair



WARNING! Advanced technology, e.g., the use of modern materials and powerful electronics, requires specially adapted maintenance and repair methods. To avoid a danger of subsequent damage to the apparatus, injuries to persons and/or the creation of additional safety hazards, all maintenance or repair work on the apparatus should be performed only by a QSC authorized service station or an authorized QSC International Distributor. QSC is not responsible for any injury, harm or related damages arising from any failure of the customer, owner or user of the apparatus to facilitate those repairs.

FCC Statement

For CXD4.3Q and CXD4.5Q



NOTE: This equipment has been tested and found to comply with the limits for a Class A digital device, pursuant to Part 15 of the FCC Rules. These limits are designed to provide reasonable protection against harmful interference when the equipment is operated in a commercial environment. This equipment generates, uses, and can radiate radio frequency energy and, if not installed and used in accordance with the instruction manual, may cause harmful interference to radio communications. Operation of this equipment in a residential area is likely to cause harmful interference in which case the user will be required to correct the interference at his own expense.

For CXD4.2Q



NOTE: This equipment has been tested and found to comply with the limits for a Class B digital device, pursuant to Part 15 of the FCC Rules.

These limits are designed to provide reasonable protection against harmful interference in a residential installation. This equipment generates, uses and can radiate radio frequency energy and, if not installed and used in accordance with the instructions, may cause harmful interference to radio communications. However, there is no guarantee that interference will not occur in a particular installation. If this equipment does cause harmful interference to radio or television reception, which can be determined by turning the equipment off and on, the user is encouraged to try to correct the interference by one or more of the following measures:

- Reorient or relocate the receiving antenna.
- Increase the separation between the equipment and receiver.
- Connect the equipment into an outlet on a circuit different from that to which the receiver is connected.
- Consult the dealer or an experienced radio/TV technician for help.

RoHS STATEMENT

The QSC CXD4.2Q, CXD4.3Q, and CXD4.5Q amplifiers are in compliance with European Directive 2011/65/EU – Restriction of Hazardous Substances (RoHS2).

The QSC CXD4.2Q, CXD4.3Q, and CXD4.5Q amplifiers are in compliance with “China RoHS” directives. The following chart is provided for product use in China and its territories:

| | | QSC CXD4.2Q, CXD4.3Q, and CXD4.5Q Amplifiers | | | | |
|-------------------------------|---|--|-----------|-----------------|---------------|-----------------|
| 部件名称 (Part Name) | 有毒有害物质或元素 (Toxic or hazardous Substances and Elements) | | | | | |
| | 铅 (Pb) | 汞 (Hg) | 镉 (Cd) | 六价铬 (Cr(vi)) | 多溴联苯 (PBB) | 多溴二苯醚 (PBDE) |
| 电路板组件 (PCB Assemblies) | X | O | O | O | O | O |
| 机壳装配件 (Chassis Assemblies) | X | O | O | O | O | O |

O: 表明这些有毒或有害物质在部件使用的同类材料中的含量是在 SJ/T11363_2006 极限的要求之下。
(O: Indicates that this toxic or hazardous substance contained in all of the homogeneous materials for this part is below the limit requirement in SJ/T11363_2006.)
X: 表明这些有毒或有害物质在部件使用的同类材料中至少有一种含量是在 SJ/T11363_2006 极限的要求之上。
(X: Indicates that this toxic or hazardous substance contained in at least one of the homogeneous materials used for this part is above the limit requirement in SJ/T11363_2006.)

Warranty

For a copy of the QSC Limited Warranty, visit the QSC website at www.qsc.com

Unpacking

There are no special unpacking instructions. You may want to keep the shipping material for the unlikely event that the amplifier should need returning for service.

Package Contents

1. Quick-Start Guide TD-000437
2. Warning Information Sheet TD-000420
3. CXD-Q Amplifier
4. IEC AC Power Cord
5. Euro-style Connector Plug, 3-pin (4)
6. Euro-style Connector Plug, 8-pin (1)
7. Euro-style Connector Plug, 3.5 mm, 16-pin (1)

Features

Amplifier Front Panel

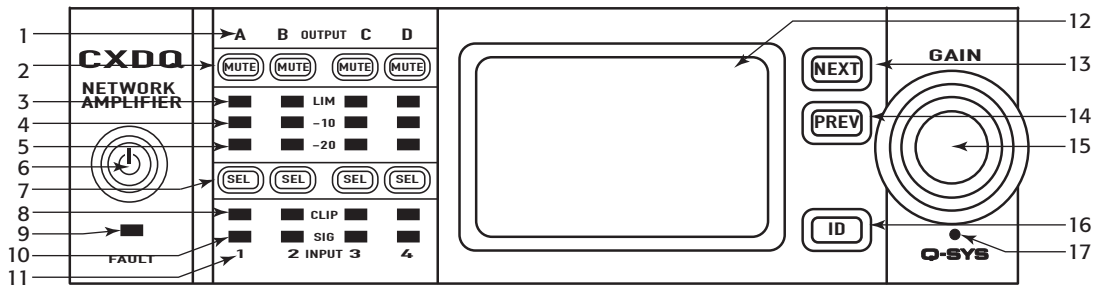

– Figure 1 –

1. Output channels are labeled A, B, C, and D
2. Output Channel Mute Buttons and LEDs (Red)
3. Output Channel Limiter LEDs (Red)
4. Output Channel -10 dB below maximum amplifier output (Blue)
5. Output Channel -20 dB below maximum amplifier output (Blue)
6. Soft Power Button (Green/Red)
7. Channel Select Buttons and LEDs (Blue for Output)
8. Input Channel Clip LEDs (Red)
9. FAULT LED
10. Input Channel Signal-Present LEDs (Blue)
11. Input channels are labeled 1, 2, 3, and 4
12. LCD Graphic Display
13. NEXT Button
14. PREV Button
15. MASTER CONTROL Knob
16. ID Button
17. Pinhole Reset

Amplifier Rear Panel



NOTE: The CXD4.3Q, and CXD4.5Q models have a different rear panel configuration than the CXD4.2Q amplifier. The difference is that the position of the fan and the eight-pin Euro-style connector and associated information are interchanged.

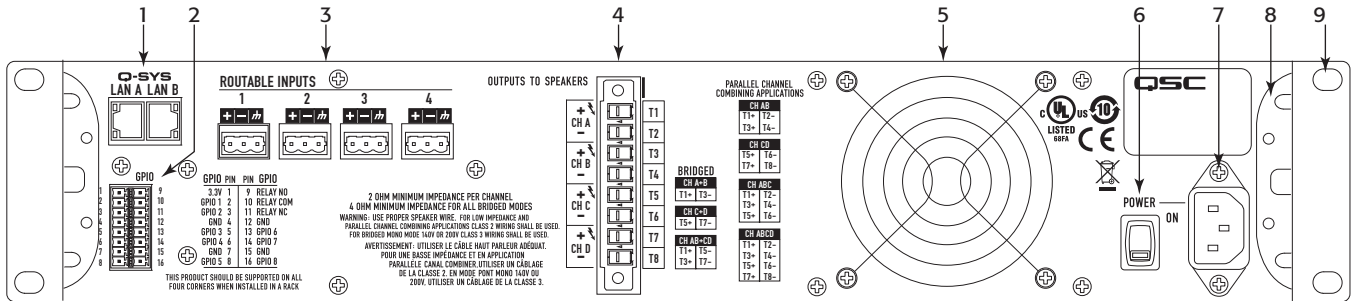

– Figure 2 –

1. RJ-45 Q-SYS Q-LAN A/B
2. GPIO Euro-style Connector, 16-pin
3. Inputs - Four three-pin Euro-style Connectors
4. One eight-pin Euro-style Loudspeaker Connector
5. Cooling fan
6. AC Power Switch
7. Locking IEC Power Connection
8. Rear Rack-mount Bracket
9. Front Rack-mount Brackets

Installation

The following steps are written in the recommended installation order.

Rack-Mount the Amplifier

The CXD-Q Series amplifiers are designed to be mounted in a standard rack-mount unit. The amplifiers are 2RU high, the CXD-Q4.3 and CXD-Q4.5 are 381 mm (15 in) deep, the CXD-Q4.2 is 229 mm (9 in) deep.

1. Secure the amplifier in the rack with eight screws (not supplied), four in front, four in back. For complete instructions, refer to TD-000050 "Rear Rack Ears Installation Guide" which can be found on the QSC Website (www.qsc.com)



CAUTION! Be sure that nothing is blocking the front or rear ventilation openings, and that each side has a minimum of 2 cm clearance.

AC Mains



WARNING! When the AC Power is on, there is a potential of having dangerous voltage at the output terminals on the rear of the amplifier. Use caution not to touch these contacts. Turn off the AC Mains disconnect switch prior to making any connections.

1. Make sure the power switch on the rear of the amplifier is off.
2. Connect the IEC power cord to the AC receptacle. (Figure 1)



WARNING! Do not turn the amplifier on at this time.

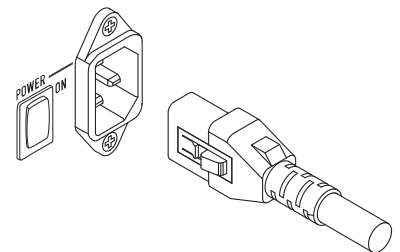

– Figure 3 –

Inputs

Connect the amplifier LAN A, and if available, LAN B, to the Q-LAN network. (Figure 6) Refer to your Q-SYS documentation for network requirements and connection detail.

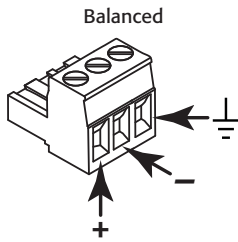

– Figure 4 –

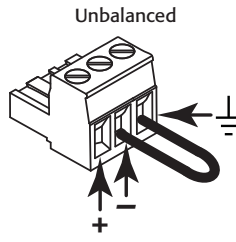

– Figure 5 –

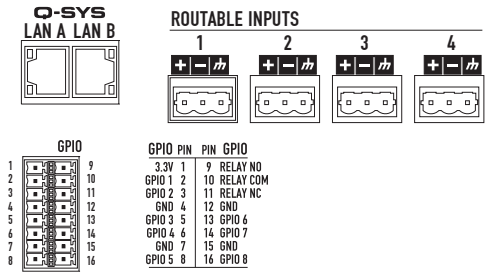

– Figure 6 –

The analog inputs are converted to digital audio in the CXD-Q amplifiers and then routed to the Q-SYS Core over the network. The digital signals show up in Q-SYS Designer at the CXD-Q input component where they can be routed as needed. Refer to the Q-SYS documentation.

1. Make sure your audio source devices are powered off.
2. Wire the audio mic- or line-level source to up to four Euro-style connectors (supplied). You can use either balanced inputs (Figure 4) or unbalanced inputs (Figure 5).
3. Plug the connectors into the appropriate receptacles (Routeable Inputs 1, 2, 3, 4) Figure 6 and Figure 7.

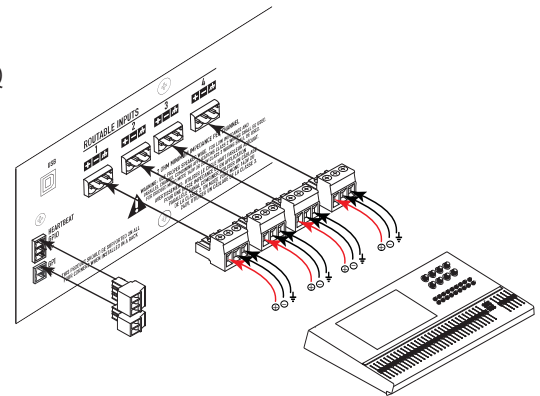

– Figure 7 –

GPIO

Refer to "GPIO" on page 13 for details about the GPIO feature.

Outputs

The configuration of the amplifier and the amplifier component in the Q-SYS design file must match. Double check that these are identical and if necessary change the configuration by following the instructions on the front panel of the amplifier. When the output configuration of the amplifier changes, the Outputs to the loudspeakers change accordingly. Use the diagrams shown in Figure 8 thru Figure 13 as a reference for wiring the loudspeakers.



CAUTION! Before turning the amplifier on, double check your output connections to be sure they are connected properly based on the output configuration specified in Q-SYS Designer.

Figure 8 through Figure 12 are examples of the three types and combinations of output configurations: Separate, Bridged and Parallel. The tables to the right of the loudspeaker connections give all the possible configurations and their connections.

Separate Channels (A B C D)

For Four Separate Loudspeakers

Use four 2-wire cables, connect to:

- T1+/T2- (Loudspeaker 1)
- T3+/T4- (Loudspeaker 2)
- T5+/T6- (Loudspeaker 3)
- T7+/T8- (Loudspeaker 4)

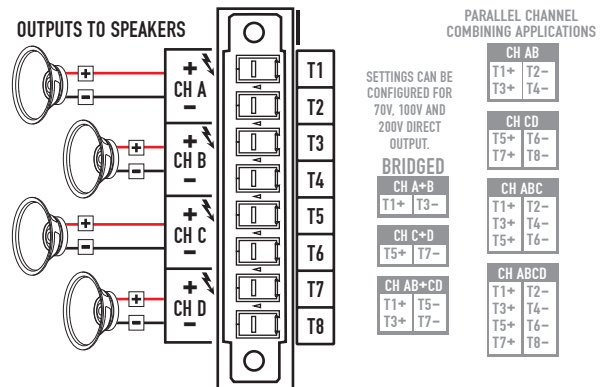
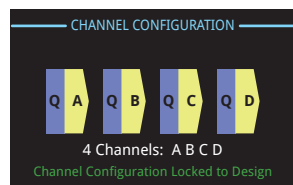

– Figure 8 –

Bridged (A+B) and Separate (C D) Channels

For A+B (Bridged) One Loudspeaker

Use one 2-wire cable connect to:

- T1+/T3-

For C & D (Separate) Two Loudspeakers

Use two 2-wire cables connect to:

- T5+/T6- for CH C
- T7+/T8- for CH D

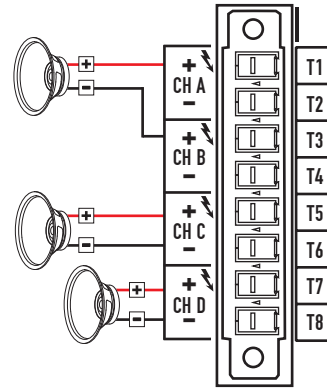
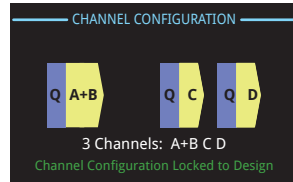

PARALLEL CHANNEL COMBINING APPLICATIONS

| | |
|-----------------------|-----|
| CH AB | |
| T1+ | T2- |
| T3+ | T4- |
| CH CD | |
| T5+ | T6- |
| T7+ | T8- |
| BRIDGED CH A+B | |
| T1+ | T3- |
| CH C+D | |
| T5+ | T7- |
| CH AB+CD | |
| T1+ | T5- |
| T3+ | T7- |
| CH ABC | |
| T1+ | T2- |
| T3+ | T4- |
| T5+ | T6- |
| CH ABCD | |
| T1+ | T2- |
| T3+ | T4- |
| T5+ | T6- |
| T7+ | T8- |

– Figure 9 –

Two Pair of Parallel Channels (AB CD)

For AB (Parallel) CD (Parallel) Two Loudspeakers

Use two 2-wire cables, connect to:

- T1+/T2-
- T5+/T6-

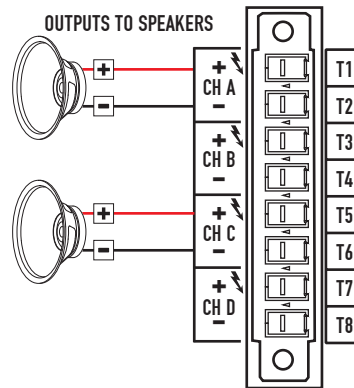
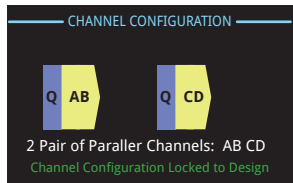

PARALLEL CHANNEL COMBINING APPLICATIONS

SETTINGS CAN BE CONFIGURED FOR 70V, 100V AND 200V DIRECT OUTPUT.

| | |
|-----------------------|-----|
| CH AB | |
| T1+ | T2- |
| CH CD | |
| T5+ | T6- |
| BRIDGED CH A+B | |
| T1+ | T3- |
| CH C+D | |
| T5+ | T7- |
| CH AB+CD | |
| T1+ | T5- |
| T3+ | T7- |
| CH ABC | |
| T1+ | T2- |
| T3+ | T4- |
| T5+ | T6- |
| CH ABCD | |
| T1+ | T2- |
| T3+ | T4- |
| T5+ | T6- |
| T7+ | T8- |

– Figure 10 –

Parallel Channels (ABCD)

For One Loudspeaker

Full power to one loudspeaker

Use one 2-wire cable, connect to:

- T3+/T4-

For Multiple Loudspeakers

Full power for multiple loudspeakers in parallel

Use up to four 2-wire cables, connect to:

- T1+/T2-
- T3+/T4-
- T5+/T6-
- T7+/T8-

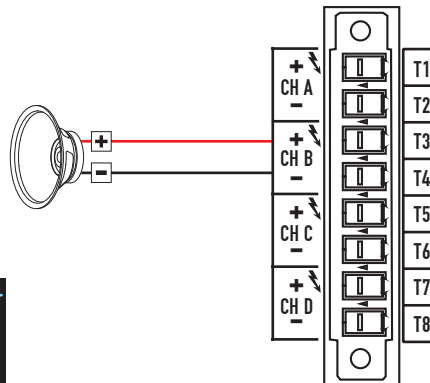
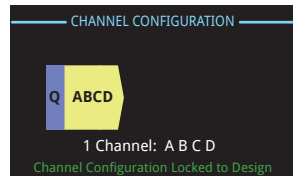

PARALLEL CHANNEL COMBINING APPLICATIONS

| | |
|-----------------------|-----|
| CH AB | |
| T1+ | T2- |
| T3+ | T4- |
| CH CD | |
| T5+ | T6- |
| T7+ | T8- |
| BRIDGED CH A+B | |
| T1+ | T3- |
| CH C+D | |
| T5+ | T7- |
| CH AB+CD | |
| T1+ | T5- |
| T3+ | T7- |
| CH ABC | |
| T1+ | T2- |
| T3+ | T4- |
| T5+ | T6- |
| CH ABCD | |
| T1+ | T2- |
| T3+ | T4- |
| T5+ | T6- |
| T7+ | T8- |

– Figure 11 –

Parallel Channels Bridged (AB + CD)

For One Loudspeaker

Full power to one loudspeaker

Use one 2-wire cable, connect to:

- T1+/T5-

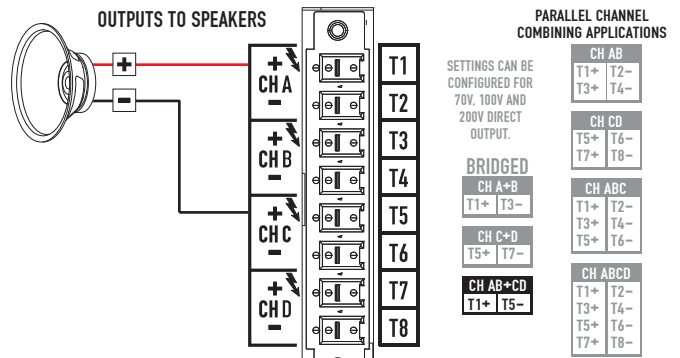
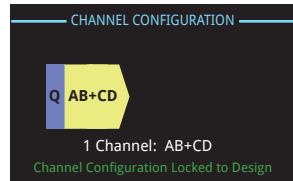

– Figure 12 –

Connect the Loudspeakers

1. Connect the loudspeaker wiring to the 8-pin Euro-style connector as needed for your amplifier's configuration.
2. Install the female 8-pin Euro-style connector onto the male connector on the rear of the amplifier as shown in Figure 13.
3. Use a Phillips screwdriver to secure the connector.

AC Power On

After connecting the outputs to the loudspeakers, you may turn the amplifier on.

1. Make sure the output gain settings for all audio-source devices (CD Players, Mixers, Instruments, etc.) are at the lowest output (max attenuation).
2. Turn on all audio sources.
3. Turn the AC Mains power switch on the back of the amplifier to ON. The amplifier starts in the state it was in when power was removed. If the amplifier is in Standby or Mute All mode (Power button LED solid red or blinking), press the Power button to change the amplifier to Run mode.
4. You can now bring up the outputs of your audio sources.

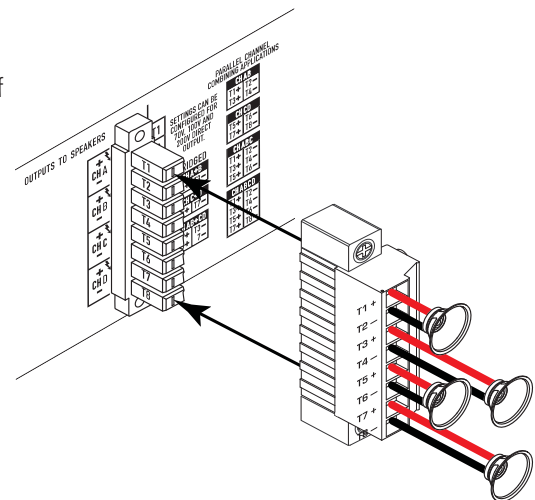

– Figure 13 –

Amplifier Control



NOTE: The following scenarios assume the amplifier is connected to the Q-SYS Core via Q-LAN. When the amplifier is not connected to the Q-SYS Core, it is in a Fault mode, and not operational.

Off Mode



- Rear power switch is off, the amplifier is not operable. The power switch is the AC Mains disconnect.
- The power button is not illuminated.
- Turn the power switch to on. The amplifier enters the mode in which it was when power was removed – Run, Mute All, or Standby.

Run Mode



- From Standby or Mute All mode, press and release the power button on the front panel. The amplifier is in Run Mode.
- The power button is illuminated green.
- The amplifier is fully operable; audio can pass.

Standby Mode



- From Mute All or Run mode, press and hold the power button on the front panel for approximately four seconds.
- The power button illuminates solid red.
- The amplifier is not operable; audio will not pass.

Mute All Mode



- From the Run Mode, quickly press and release the power button.
- The power button flashes red, all output Mute buttons are red.
- The amplifier output is disabled, but the front panel is fully operable.

Master Control Knob



- Adjusts the Gain for the selected channel or channels. At least one channel must be selected.
- When one or more channels are selected, turn the Master Control knob to jump to the Gain screen. After a few seconds with no activity, it returns to the earlier screen.
- If there is more than one channel selected, and the gains for those channels are different, the difference is maintained unless the gain is raised or lowered to the limits for both channels.

NEXT & PREV Buttons



- Navigates forward and backwards through the screens.

ID Button



- Press this button to display a screen with the amplifier's network name. In addition, the ID buttons on the associated Q-SYS Amplifier component and the associated Q-SYS Configurator item flashes. Press again, or click one of the other ID buttons, to stop the flashing and exit the screen.
- When prompted, press this button to change the amplifier configuration to match the configuration of the associated Q-SYS design.

SEL Buttons



- Use these buttons to select an output channel in order to change the Gain.
- Select more than one channel to change multiple gain settings at the same time.
- If two or more outputs are bridged or in parallel, pressing one button in the group selects all channels in that bridged or parallel group.

Mute Buttons



- Use these buttons to mute the audio of the associated output channel.
- When the output configuration is changed, the Mute buttons are engaged automatically. You must manually unmute the channels.
- When a new design is sent to the amplifier from Q-SYS, the outputs are muted while the amplifier is offline.

Pinhole Reset



- Insert a paper clip or similar tool into the pinhole then press and hold for 5 seconds to reset the amplifier to the factory default settings. The default settings include network settings, and amplifier name.

Input and Output Signal Flow

The CXD-Q amplifiers have four Mic/Line Inputs and four amplified Outputs on the rear of the amplifier. The Inputs and Outputs on the rear of the amplifier are not connected inside the amplifier.

The analog inputs are converted to digital audio in the amplifier (1) and then routed to the Q-SYS Core via Q-LAN (LAN A, LAN B) (2). The digital signals are brought into the Q-SYS design to the CXD-Q Amplifier Input component (3). From the CXD-Q Input component the signals can be sent DSP in the Core (4), and routed anywhere else within the Q-SYS system.

Likewise, in Q-SYS Designer digital signals are received at the CXD-Q Output component (5) and fed from the Q-SYS Core to the amplifier via Q-LAN (6), converted to analog signals and then to the amplified outputs of the CXD-Q (7). The CXD-Q output component can have one to four outputs depending on the configuration of the amplifier. The desired configuration is selected in the Q-SYS Designer properties menu for that amplifier.

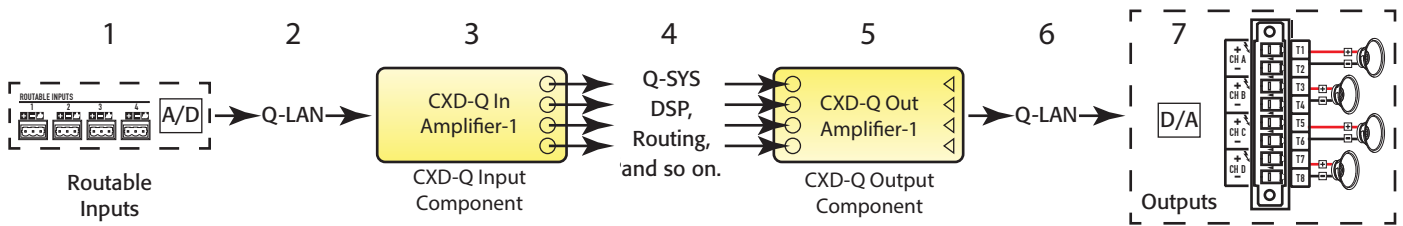

– Figure 14 –

Screens

Channel Configuration Screens

Refer to Figure 15

- Graphic representations of the amplifier's output configuration. Inputs (Q) are from Q-SYS, outputs (A-D) show the amplifier channels and their configuration.
- Text indicating how many channels, and the output configuration. For possible configurations refer to the Q-SYS help for the CXD-Q Amplifier component.
- Status of the amplifier and Q-SYS design indicating the design and amp are in sync.
- Status of the amplifier indicating that action is necessary to synchronize the design and amplifier.
- Action you need to perform to change the amplifier configuration. Press the ID button to the right of the message.

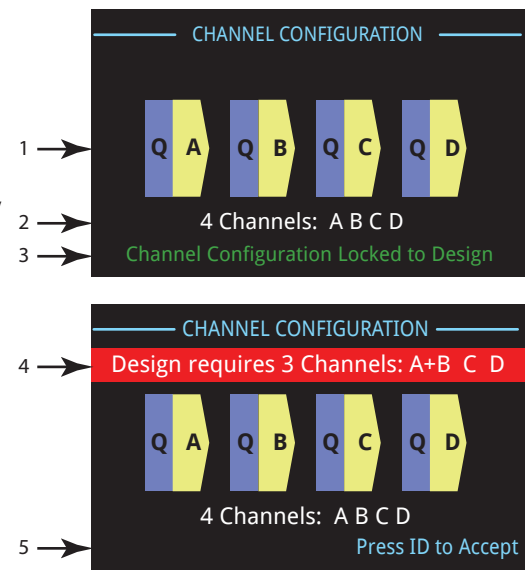

– Figure 15 –

Status Screen

Refer to Figure 16

- DEVICE: This is the hostname (network name) of the amplifier. A default name is given at the factory, similar to the example. You may change the name in the Q-SYS Configurator.
- DESIGN: This is the name of the Q-SYS design containing the amplifier. The amplifier must be in a running design to operate.
- STATUS: Displays the current status of the amplifier both in text and color. The following is a list of possible status colors, and some example conditions.
 - OK – Green – Audio is good, hardware is good.
 - Compromised – Orange – Audio is good but a redundancy mechanism is active (one LAN down but the other is still up) or a non-fatal hardware problem exists (fans too slow, temperature higher than expected, etc.)
 - Fault – Red – Audio is not passing, or hardware is malfunctioning or mis-configured (amplifier power off, audio streams broken, amplifier fault, loudspeaker short circuit, etc.)
 - Initializing – Blue – In the process of initialization, and design start. Audio is not passed.

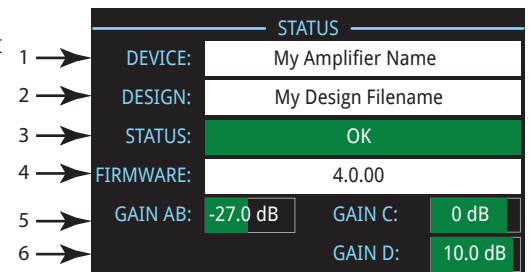

– Figure 16 –

4. FIRMWARE: The Q-SYS Designer firmware version. To update the firmware:
 - a. The version you want to use must be installed on your PC,
 - b. The amplifier must be connected to the network, and turned on.
 - c. Open the Q-SYS design containing the amplifier and select "Save to Core and Run" from the File menu.
 - d. The amplifier Q-LAN processor and any other Q-SYS peripherals in the design are automatically updated.
5. GAIN A - D: Displays the current Gain setting for each channel. If channels are combined, they are displayed together. The green background gives a graphical indication of the Gain.

LAN A / LAN B Screen

Refer to Figure 17

1. Default IP Address. You can change this and the other parameters in Q-SYS Configurator. LAN A is required, and cannot be turned off.
2. Default Netmask.
3. Default Gateway.
4. LAN B is not required, as indicated by empty fields in Figure 17.

| LAN A | |
|-----------------|-----------------|
| 1 → IP ADDRESS: | 192.168.xxx.xxx |
| 2 → NETMASK: | 255.255.0.0 |
| 3 → GATEWAY: | 0.0.0.0 |
| LAN B | |
| 4 → IP ADDRESS: | |
| NETMASK: | |
| GATEWAY: | |

– Figure 17 –

Health Screen

Refer to Figure 18

1. FAN RPM – varies depending on the temperature.
2. PSU TEMP – Temperature of the Power Supply Unit.
 - 55° C causes a compromised state for the amplifier.
 - 63° C Mutes Audio
3. Channels A&C, and B&D Temp (Heat Sink Temperature)
 - Thermal Limiting starts at 69° C, shows a compromised state
 - Thermal Shutdown at 80° C
4. Voltage Rails
 - CXD4.3Q & CXD4.5Q
 - » VRail 1 = +147 VDC +/- 5 V typical
 - » VRail 2 = -147 VDC +/- 5 V typical
 - CXD4.2Q
 - » VRail 1 = +85 VDC +/- 5 V typical
 - » VRail 2 = -85 VDC +/- 5 V typical

| HEALTH | |
|---------------|--------|
| 1 → FAN RPM: | 1109 |
| 2 → PSU TEMP: | 35.3°C |
| 3 → A&C Temp: | 35.4°C |
| 3 → B&D Temp: | 35.3°C |
| 4 → VRAIL 1: | 149 |
| 4 → VRAIL 2: | -151 |

– Figure 18 –

Output Screens

Refer to Figure 19

Each output or group of outputs has a dedicated screen. Figure 19 is an example of Output A.

- GAIN** – The amount of gain applied to the input signal. Controlled by the GAIN knob on the front panel of the amplifier, or the GAIN control in the CXD-Q Output component in the Q-SYS Design.
- INPUT** – The level of the audio signal applied to the CXD-Q Output component in the Q-SYS design. The CXD-Q Output component is the connection to the output section of the amplifier. This meter reading can be changed from RMS to Peak in the Amplifier Out component in the Q-SYS design.
- VOLTAGE** - The voltage being delivered to the loudspeaker. This reading can be RMS or Peak depending on the Meter Select setting in the Q-SYS design for the associated channel.
- POWER** – The power of the amplifier / loudspeaker circuit. This reading can be RMS or Peak depending on the Meter Select setting in the Q-SYS design for the associated channel.
- HEADROOM** – The amount of room left before reaching the amplifier's maximum capabilities.
- DAC LIMIT** – When illuminated, this indicates that the signal to the D to A Converter is larger than can be reproduced and a limiter has been engaged to prevent clipping. This is an indication that the gain structure is not correct.
- PROTECT** – When illuminated, this indicates that the channel is in Protect Mode. Usually due to driving too low of an impedance for too long.
- LIMIT** – When illuminated, this indicates the amplifier limiter is active. This occurs if the signal is driving the power, current, or voltage above the amplifier rated values or due to thermal limiting.

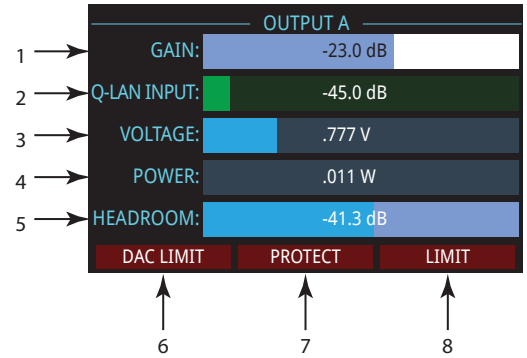

– Figure 19 –

Output Gains Screen

Refer to Figure 20

The Output Gains screen provides a quick overview of all outputs and is the screen on which GAIN adjustments are made.

Use the NEXT or PREV buttons to access this screen or, press one or more of the SEL buttons to access the screen and make GAIN adjustments for the selected channels.

- The highlighted background indicates that the Channel is selected by the SEL button.
- Channel – the channels display according to the configuration of the amplifier.
- Output Gain – the output gain is controlled by the GAIN knob on the amplifier or with the Gain control in the CXD-Q Output component in the Q-SYS design.
- Q-LAN Input Level – the level of the audio signal applied to the CXD-Q Output component in the Q-SYS design. The CXD-Q Output component is the connection to the output section of the amplifier.
- Voltage – The voltage applied to that output.
- Output B is combined in parallel with Output A, the slot for Output B is removed.

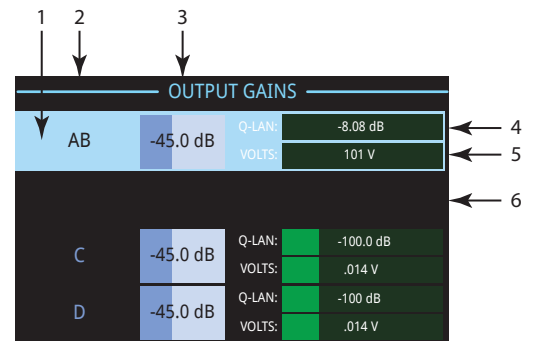

– Figure 20 –

GPIO

| Connector Pin | GPIO # and Function | Specifications |
|---------------|------------------------|--|
| 1 | 3.3 V | 100 mA max (power cycle to reset current limiting) |
| 2 | GPIO 1 | 5mA in/out, 3.3V max, 127Ω resistor in series |
| 3 | GPIO 2 | 5mA in/out, 3.3V max, 127Ω resistor in series |
| 4 | GND | Ground |
| 5 | GPIO 3 | 5mA in/out, 3.3V max, 127Ω resistor in series |
| 6 | GPIO 4 | 5mA in/out, 3.3V max, 127Ω resistor in series |
| 7 | GND | Ground |
| 8 | GPIO 5 | 18mA in/out max, 3.3V max, 127Ω resistor in series |
| 9 | RELAY NO ¹ | Relay Normally Open |
| 10 | RELAY COM ¹ | Relay Common |
| 11 | RELAY NC ¹ | Relay Normally Closed |
| 12 | GND | Ground |
| 13 | GPIO 6 | 18mA in/out max, 3.3V max, 127Ω resistor in series |
| 14 | GPIO 7 | 18mA in/out max, 3.3V max, 127Ω resistor in series |
| 15 | GND | Ground |
| 16 | GPIO 8 | 18mA in/out max, 3.3V max, 127Ω resistor in series |

¹ Nominal switching capacity is 30 VDC at 2 A for a total of 60 W maximum. The maximum voltage is 220 VDC if the current is limited to observe the maximum power rating (60 W).

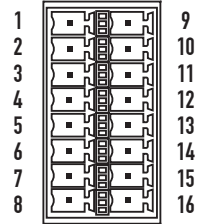

– Figure 21 –

Examples

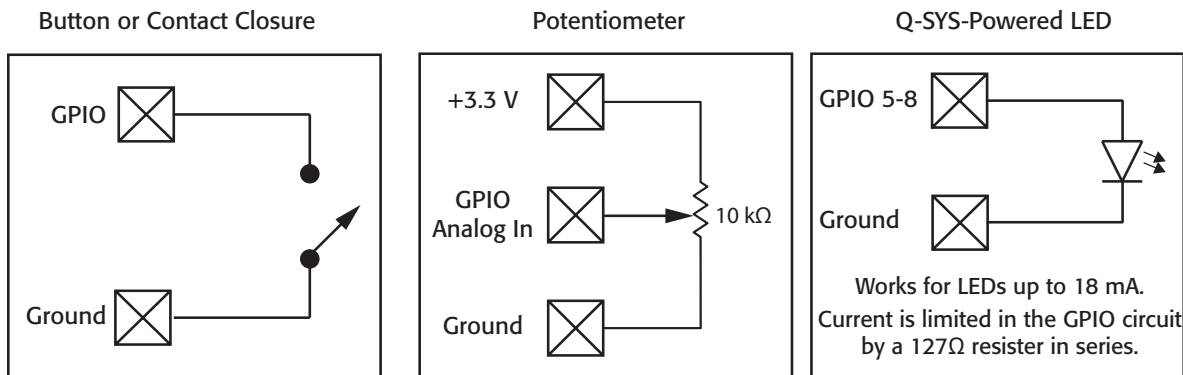

– Figure 22 –

Specifications

| | CXD4.2Q | | CXD4.3Q | | CXD4.5Q | | |
|--|--|----------------------------|--|----------------------------|-------------------------------------|----------------------------|----------------------------|
| Channel Configuration | Peak ¹ | Continuous ² | Peak ¹ | Continuous ² | Peak ¹ | Continuous ² | |
| 70 V or 100 V Mode | 70 V | N/A ³ | N/A ³ | 500 W | 500 W | 1000 W | 1000 W |
| | 100 V | N/A ³ | N/A ³ | 625 W | 625 W | 1250 W | 1250 W |
| 4 Independent Channels A, B, C, D | 8 Ω | 500 W | 400 W | 900 W | 625 W | 1200 W | 1150 W |
| | 4 Ω | 700 W | 400 W | 1400 W | 625 W | 2000 W | 1250 W |
| | 2 Ω | 625 W | 325 W | 1200 W | 625 W | 1600 W | 625 W |
| 2 Channels BTL Bridged A+B or C+D Doubles Voltage | 8 Ω | 1200 W ⁵ | 800 W ⁵ | 2400 W ⁵ | 1250 W ⁵ | 4000 W ⁵ | 2250 W ⁵ |
| | 4 Ω | 1500 W ⁵ | 600 W ⁵ | NR ⁴ | NR ⁴ | NR ⁴ | NR ⁴ |
| | 2 Ω | NR ⁴ | NR ⁴ | NR ⁴ | NR ⁴ | NR ⁴ | NR ⁴ |
| 2 Channels Parallel AB or CD Doubles Current | 8 Ω | 500 W | 400 W | 1300 W | 1150 W | 1250 W | 1200 W |
| | 4 Ω | 950 W | 800 W ⁵ | 2000 W ⁵ | 1250 W ⁵ | 2400 W ⁵ | 2250 W ⁵ |
| | 2 Ω | 1200 W ⁵ | 800 W ⁵ | 2500 W ⁵ | 1250 W ⁵ | 4000 W ⁵ | 2100 W ⁵ |
| 1 Channel 3CH Parallel ABC Triples Current | 8 Ω | 500 W | 400 W | 1400 W | 1150 W | 1400 W | 1150 W |
| | 4 Ω | 950 W | 800 W | 2400 W | 2000 W | 2500 W | 2400 W |
| | 2 Ω | 1800 W | 1200 W | 3500 W | 2500 W | 4500 W | 4100 W |
| 1 Channel Bridged/Parallel AB+CD Doubles Current and Voltage | 8 Ω | 1600 W ⁵ | 1500 W ⁵ | 3500 W ⁵ | 2500 W ⁵ | 4500 W ⁵ | 4200 W ⁵ |
| | 4 Ω | 2500 W ⁵ | 1600 W ⁵ | 5000 W ⁵ | 2500 W ⁵ | 7500 W ⁵ | 4200 W ⁵ |
| | 2 Ω | NR ⁴ | NR ⁴ | NR ⁴ | NR ⁴ | NR ⁴ | NR ⁴ |
| 1 Channel 4CH Parallel ABCD Quadruples Current | 8 Ω | 500 W | 400 W | 1400 W | 1150 W | 1600 W | 1150 W |
| | 4 Ω | 1000 W | 800 W | 3000 W | 2500 W | 3000 W | 2300 W |
| | 2 Ω | 1700 W ⁵ | 1600 W ⁵ | 5000 W ⁵ | 2500 W ⁵ | 5300 W ⁵ | 4200 W ⁵ |
| Typical Distortion | | | | | | | |
| 8Ω | 0.01–0.03% | | 0.01–0.03% | | 0.01–0.03% | | |
| 4Ω | 0.03–0.06% | | 0.03–0.06% | | 0.03–0.06% | | |
| Maximum Distortion 4Ω–8Ω | 1.0% | | 1.0% | | 1.0% | | |
| Frequency Response (8Ω) | 20 Hz–15 kHz ±0.2 dB | | 20 Hz–15 kHz ±0.2 dB | | 20 Hz–15 kHz ±0.2 dB | | |
| | 20 Hz–20 kHz +0.2 dB / -0.7 dB | | 20 Hz–20 kHz +0.2 dB / -0.7 dB | | 20 Hz–20 kHz +0.2 dB / -0.7 dB | | |
| Noise | | | | | | | |
| Unweighted Output Unmuted | -101 dB | | -101 dB | | -101 dB | | |
| Weighted Output Muted | -109 dB | | -109 dB | | -109 dB | | |
| Gain (+4 dBu setting) | 33.5 dB | | 35.5 dB | | 38.5 dB | | |
| Constant Sensitivity | | | | | | | |
| Damping Factor | >150 | | >150 | | >150 | | |
| Q-SYS Analog Signal Inputs | Four mic/line, configured and routed in Q-SYS Designer; not connected to amplifier output channels | | | | | | |
| Input Impedance | >10k ohms, balanced or unbalanced | | >10k ohms, balanced or unbalanced | | >10k ohms, balanced or unbalanced | | |
| Front Panel Controls and Indicators | Power • Channel MUTE Buttons • Channel SELECT Buttons • Channel Input Signal and CLIP LED Indicators • Channel Output and LIMIT LED Meters • NEXT, PREV, ID Buttons • Control Knob • FAULT LED • Pinhole Reset | | | | | | |
| Rear Panel Controls and Indicators | AC power disconnect switch LAN A link and activity LEDs LAN B link and activity LEDs | | | | | | |
| Rear Panel Connectors | | | | | | | |
| Input | 3-pin Euro style (4) | | | | | | |
| Output (Loudspeakers) | 8-pin Euro style | | | | | | |
| Network | LAN A / LAN B RJ45 | | | | | | |
| GPIO | 16 pin Euro style | | | | | | |
| Amplifier and Load Protection | Short Circuit, Open Circuit, Thermal, RF Protection. On/Off Muting, DC Fault Shutdown, Active Inrush Limiting, Input Current Limiting | | | | | | |
| AC Power Input | Universal Power Supply 100-132/200–240 VAC, 50–60 Hz | | Universal Power Supply 100–240 VAC, 50–60 Hz | | | | |
| Dimensions (HWD) | 3.5" × 19" × 12" | | 3.5" × 19" × 16" | | 3.5" × 19" × 16" | | |
| | (89 mm × 482 mm × 305 mm) | | (89 mm × 482 mm × 406 mm) | | (89 mm × 482 mm × 406 mm) | | |
| Weight Net / Shipping | 18.5 lb (8.4 kg) / 22 lb (10.0 kg) | | 21.0 lb (9.5 kg) / 25 lb (11.3 kg) | | 22.0 lb (10.0 kg) / 26 lb (11.8 kg) | | |
| Agency Approvals | UL, CE, RoHS/WEEE compliant, FCC Class A (conducted and radiated emissions) | | | | | | |

¹ Peak Power – 20 ms 1 kHz sine burst, all channels driven

² Continuous Power – EIA 1 kHz 1% THD, all channels driven

³ 70V & 100V are available on CXD-Q4.2 only when channels are bridged

⁴ NR – Not Recommended due to excessive current draw

⁵ **BOLD** indicates optimal configuration for the load and channel count

Heat Loss Charts

Heat losses are the thermal emissions from an amplifier while it is operating. It comes from dissipated waste power—i.e., real AC power in minus audio power out. Measurements are provided for various loads at idle, 1/8 of average full power, 1/3 of average full power, and full power, with all channels driven simultaneously. For typical usage, use the idle and 1/8 power figures. This data is measured from representative samples; due to production tolerances, actual heat emissions may vary slightly from one unit to another. Bridged mono into 8 ohms is equivalent to 4 ohms per channel; into 4 ohms is equivalent to 2 ohms per channel.

| | BTU/hr | kcal/hr |
|-------------|--------|---------|
| Idle | | |
| CXD4.2Q | 180 | 46 |
| CXD4.3Q | 225 | 57 |
| CXD4.5Q | 286 | 72 |

| Load per Channel | 8Ω | | 4Ω | | 2Ω | | 25V-70V-100V | |
|--------------------|--------|---------|--------|---------|--------|---------|--------------|---------|
| | BTU/hr | kcal/hr | BTU/hr | kcal/hr | BTU/hr | kcal/hr | BTU/hr | kcal/hr |
| 1/8th Power | | | | | | | | |
| CXD4.2Q | 432 | 109 | 476 | 120 | 597 | 150 | nr | nr |
| CXD4.3Q | 684 | 172 | 794 | 200 | 1040 | 262 | nr | nr |
| CXD4.5Q | 811 | 204 | 1144 | 288 | 1124 | 283 | nr | nr |
| 1/3rd Power | | | | | | | | |
| CXD4.2Q | 849 | 214 | 873 | 220 | 1215 | 306 | nr | nr |
| CXD4.3Q | 983 | 248 | 1261 | 318 | 1869 | 471 | nr | nr |
| CXD4.5Q | 881 | 222 | 1708 | 430 | 1737 | 438 | nr | nr |
| Full Power | | | | | | | | |
| CXD4.2Q | 1352 | 341 | 1478 | 372 | 2120 | 534 | nr | nr |
| CXD4.3Q | 2498 | 629 | 2925 | 737 | 4198 | 1058 | nr | nr |
| CXD4.5Q | 3116 | 785 | 5318 | 1340 | 4208 | 1060 | nr | nr |

Idle

Thermal loss at idle or with very low signal level.

1/8 Power

Thermal loss at 1/8 of full power is measured with pink noise. It approximates operating with music or voice with light clipping and represents the amplifier's typical "clean" maximum level, without audible clipping. Use these figures for typical maximum level operation.

1/3 Power

Thermal loss at 1/3 of full power is measured with pink noise. It approximates operating with music or voice with very heavy clipping and a very compressed dynamic range.

Full Power

Thermal loss at full power is measured with a 1 kHz sine wave. However, it does not represent any real-world operating condition.

**Mailing Address:**

QSC, LLC
1675 MacArthur Boulevard
Costa Mesa, CA 92626-1468 U.S.
Main Number: (714) 754-6175
World Wide Web: www.qsc.com

Sales & Marketing:

Voice: (714) 957-7100 or toll free (U.S. only) (800) 854-4079
FAX: (714) 754-6174
E-mail: info@qsc.com

Q-SYS™ Customer Support**Application Engineering and Technical Services**

Monday - Friday 7 AM to 5 PM PST (Excludes Holidays)
Tel. 800-772-2834 (U.S. only)
Tel. +1 (714) 957-7150

Q-SYS 24/7 Emergency Support*

Tel: +1-888-252-4836 (U.S./Canada)
Tel: +1-949-791-7722 (non-U.S.)



*Q-SYS 24/7 Support is for Emergency assistance with Q-SYS systems only. 24/7 support guarantees a call back within 30 min after a message is left. Please include, Name, Company, Call Back Number and description of the Q-SYS emergency for prompt call back. If calling during business hours please use the standard support numbers above.

Q-SYS Support Email

qsysupport@qsc.com
(Immediate email response times not guaranteed)

QSC

Technical Services
1675 MacArthur Blvd.
Costa Mesa, CA 92626 U.S.
Tel: 800-772-2834 (U.S. only)
Tel: +1 (714) 957-7150
FAX: +1 (714) 754-6173